

12th June 2009

Dear Parents,

We have prepared a class pack of work for your child which you may collect from school from Monday 15th June. In addition daily worksheets will be posted on our school home page: www.kcis.edu.hk

For those parents who have not yet returned their school library books, please do so when you collect your child's class pack.

Please see the list below for details of the daily tasks.

Monday 15th June

- Let's Learn about Transportation Book- Write child's name and colour the cover page, trace letters of lorry/helicopter and colour
- Mandarin Orange Book 3- complete page 3
- Play dough recipe: Make and play with your child

2cups flour, 1 cup salt, 2 tablespoons cooking oil, 2 dessert spoons cream of tartar, food colouring

Method: Put all ingredients into pan and stir together over a moderate flame until dough comes together and is firm. Leave to cool then knead well for five minutes.

Tuesday 16th June

- Transportation Book- trace letters of motorbike/tractor and colour
- Play with transportation toys count wheels and name colours of each item
- Mandarin Orange Book 3- complete page 4

Wednesday 17th June

- Tire and wheel pattern-follow instructions on the worksheet
- Matching front and back transportation worksheet
- Mandarin Orange Book 3- page 5

Thursday 18th June

- Castle picture- colour and use various materials to decorate the castle
- Use lego or similar to build a castle
- Mandarin Orange Book 3- page 6

Friday 19th June

- Print and design a King or Queen's crown:

King: www.play.powerhousemuseum.com

Queen: www.verybestkids.com

Mandarin Orange Book 3- page 7

Monday 22nd June

- Print the Prince or Princess worksheet- colour/decorate, cut and assemble using a toilet roll

Mandarin Orange Book 3- page 8

Tuesday 23rd June

- Learn action and words to the 'Thorn Rosa' song. To the tune of Mary had a little lamb'

www.dltk-teach.com

- Mandarin Orange Book 3- page 9

Wednesday 24th June

- Finger puppets- colour, cut and assemble

Find a story about Fairy Castle or go to the web "The King's Breakfast"

www.mightybook.com/story-books.htm

- Mandarin Orange Book 3- page 10

Thursday 25th June

- Phonics, revise letters and sounds_a-z in your pink book or :
www.yourchildlearns.com/letters/lettersounds.htm

- Mandarin Orange Book 3- page 11

Additional work and web sites if you have time:

- Name writing practice: www.handwritingworksheets.com
- Stories: <http://www.bbc.co.uk/cbeebies/stories/jackbeanstalk.shtml> or
www.bbc.co.uk/cbeebies/stories

Name: _____

Class: _____

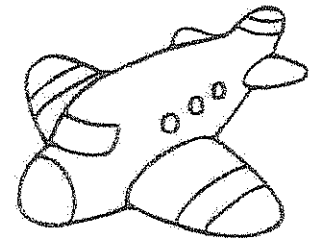
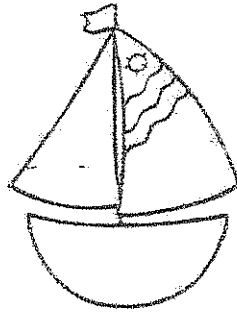
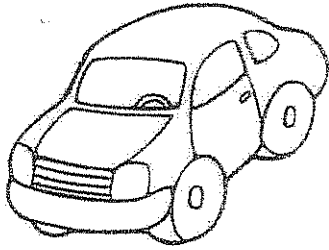

Let's

Learn About Transportation

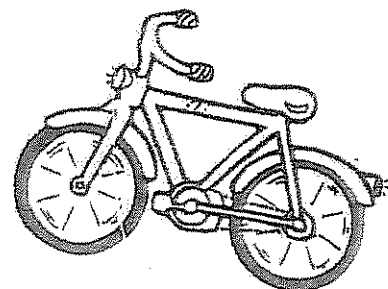
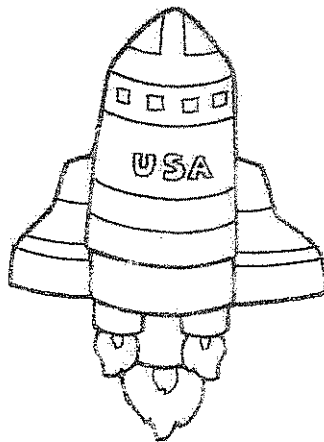
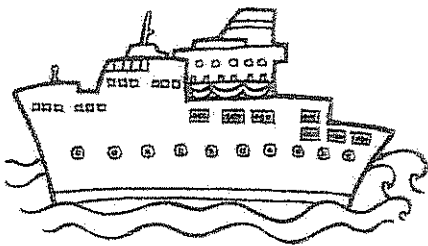

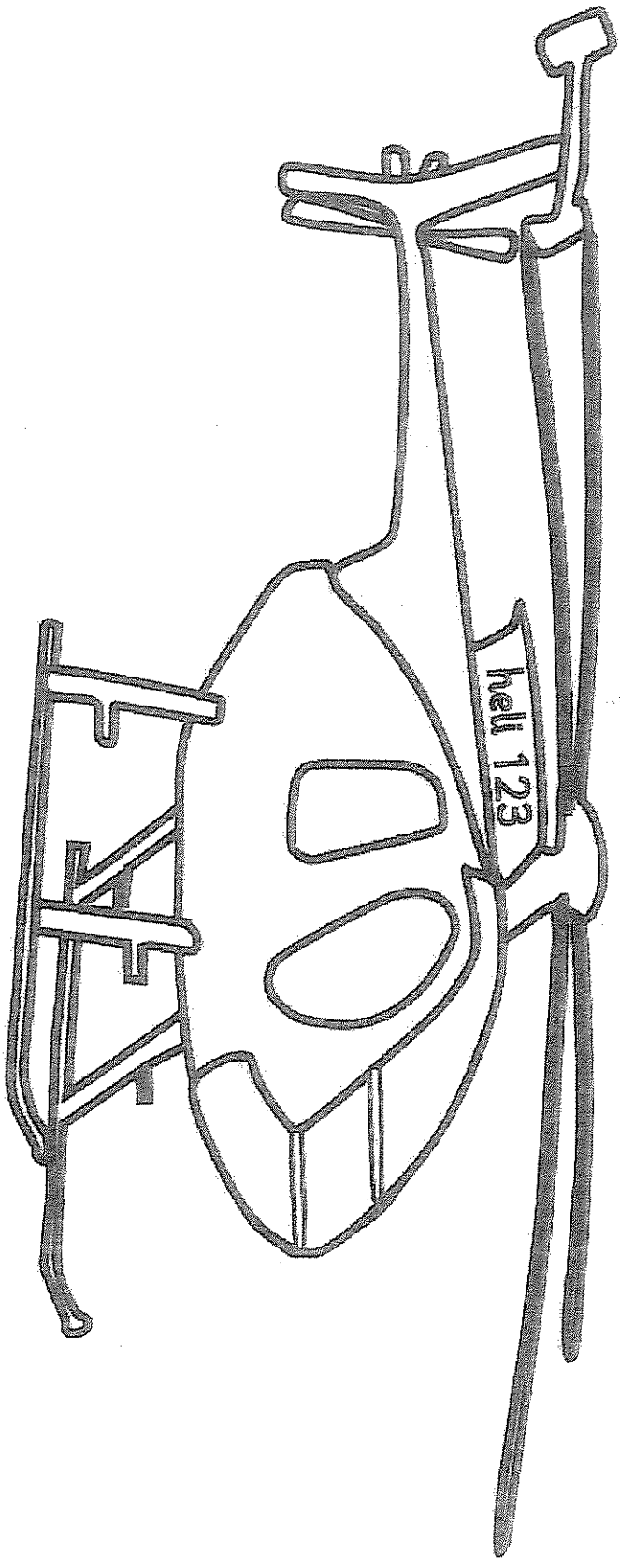

helicopter

Lorry

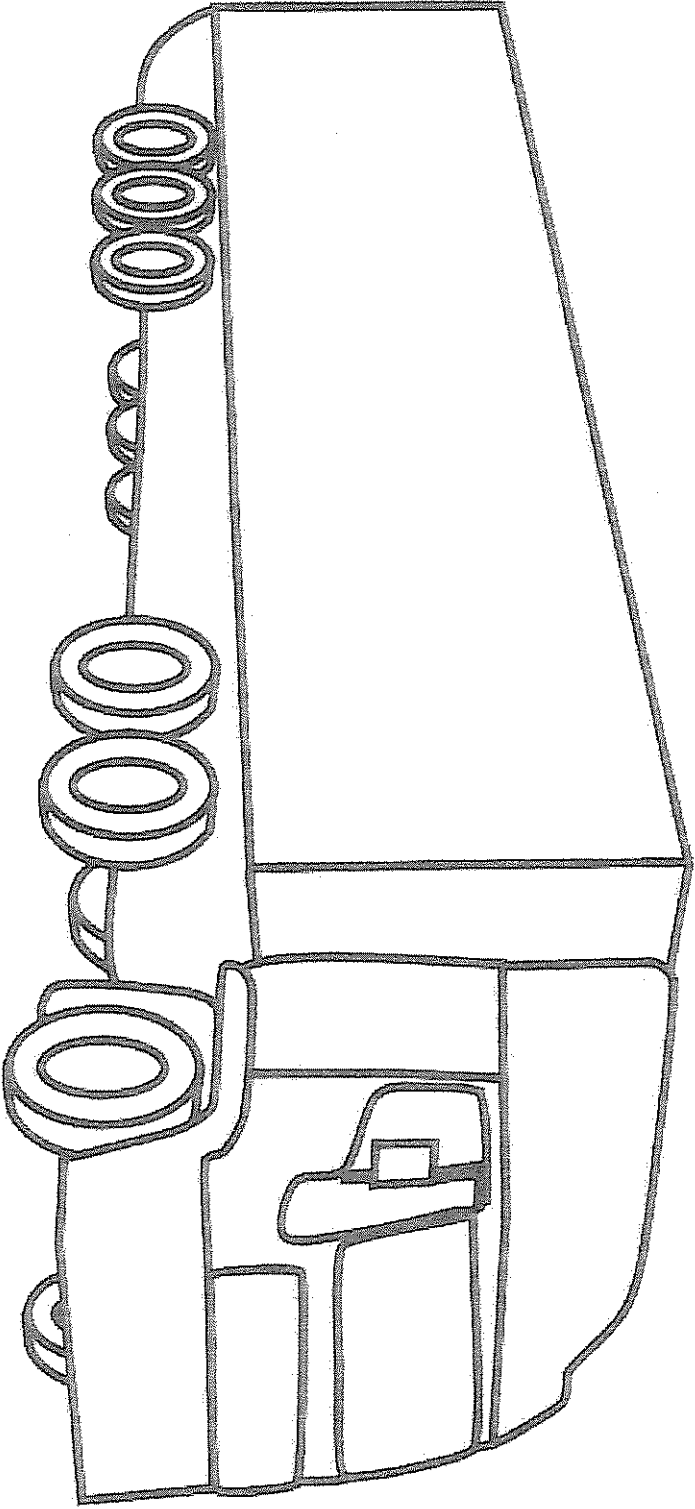

PLAY DOUGH RECIPE.

2 CUPS FLOUR
1 CUP SALT
2 CUPS WATER
2 TABLESPOONS COOKING OIL
2 DESSERT SPOONS CREAM OF TARTAR
FOOD COLOURING.

METHOD.

PUT ALL INGREDIENTS INTO PAN AND STIR
TOGETHER OVER A MODERATE FLAME UNTIL
DOUGH COMES TOGETHER AND IS FIRM.
LEAVE TO COOL THEN KNEAD WELL FOR FIVE
MINUTES.

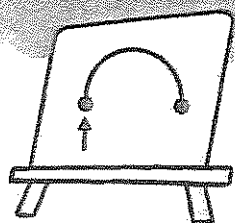

太陽傘

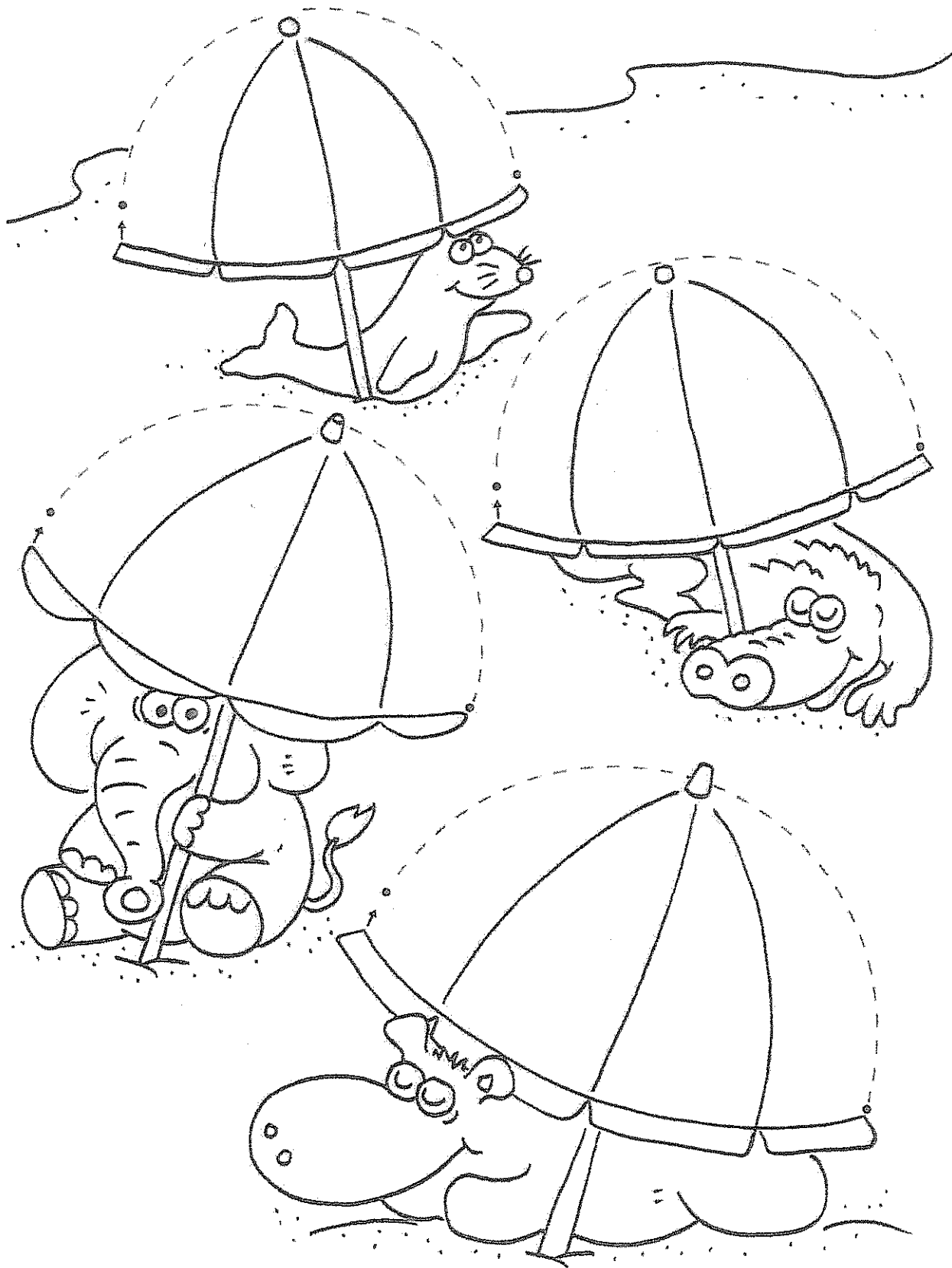

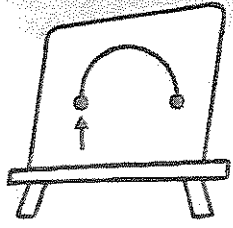

打球

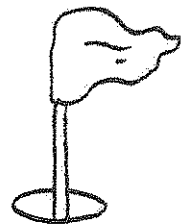
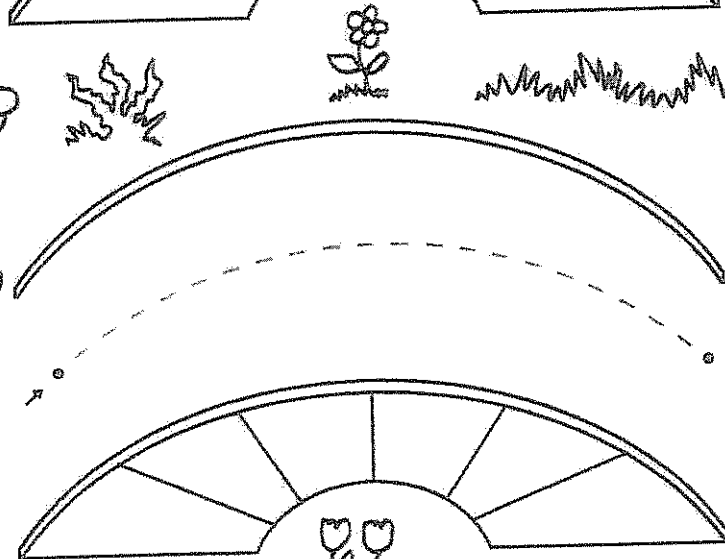
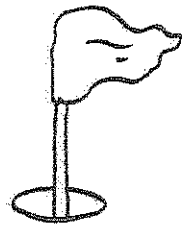
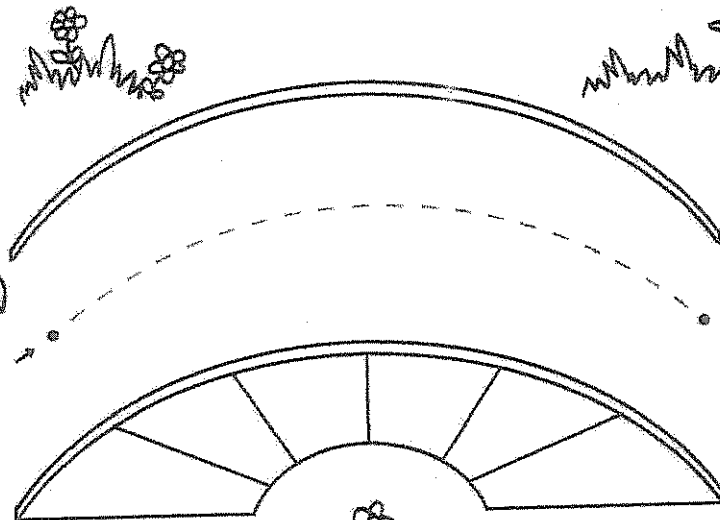
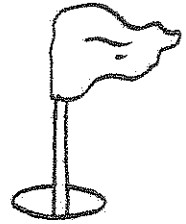
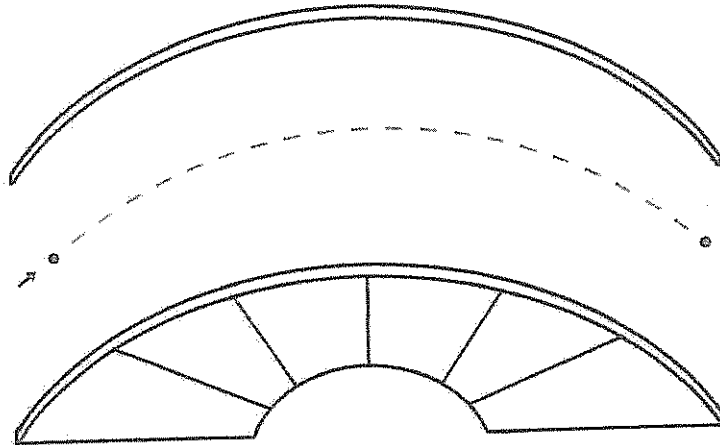

motorbike

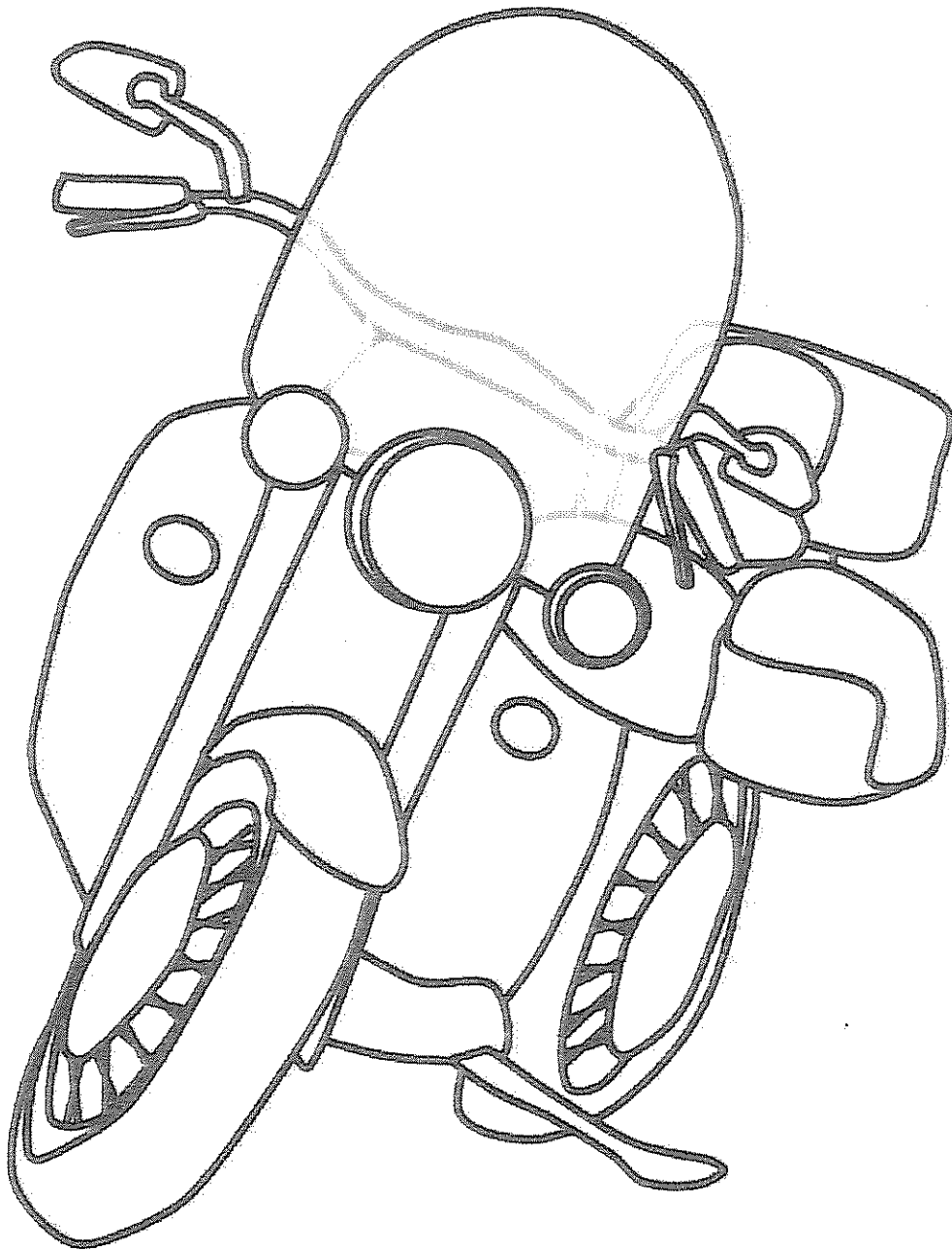

tractor

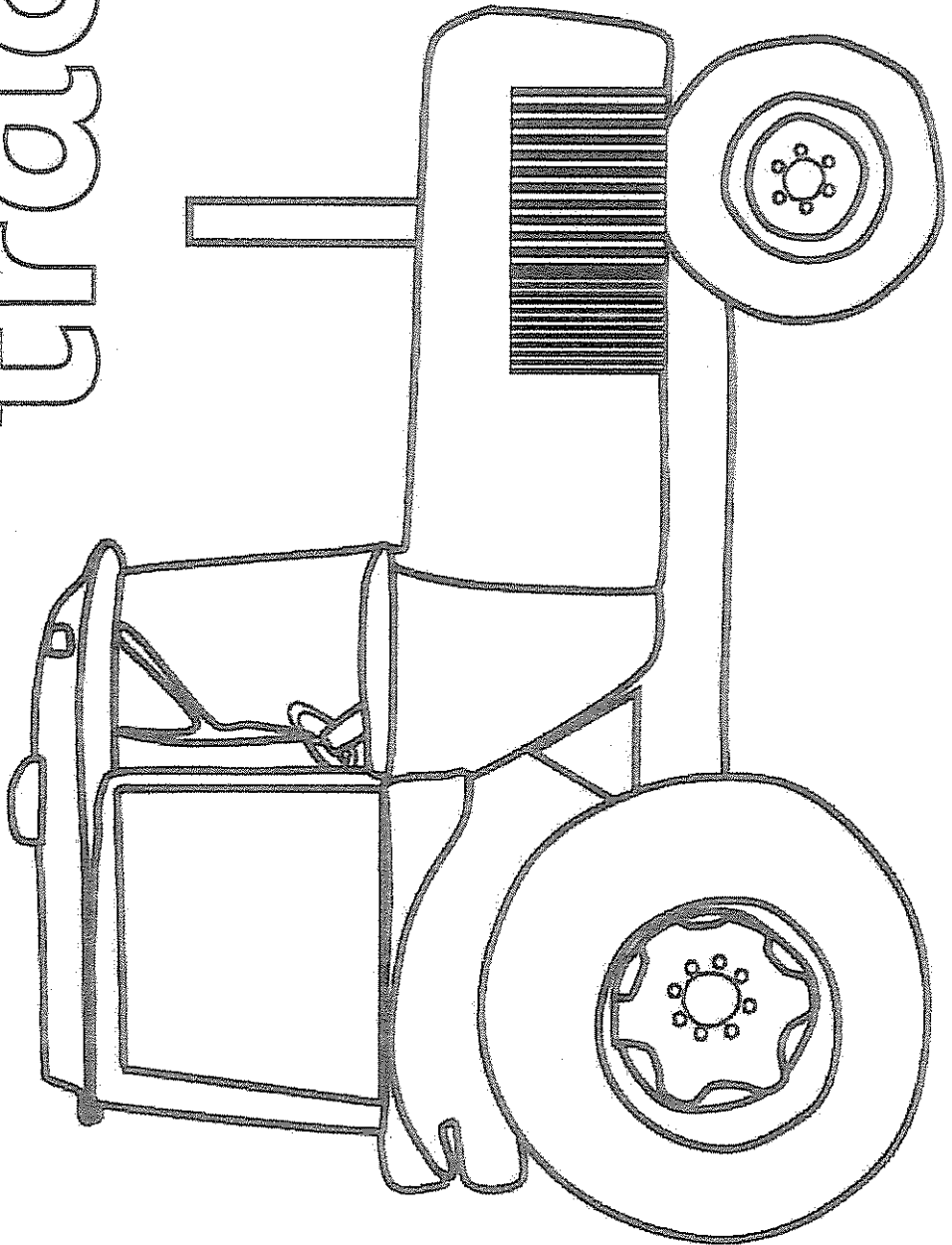

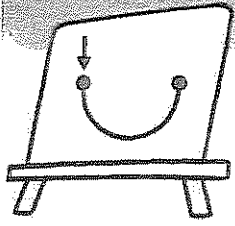
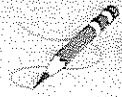

小花碗

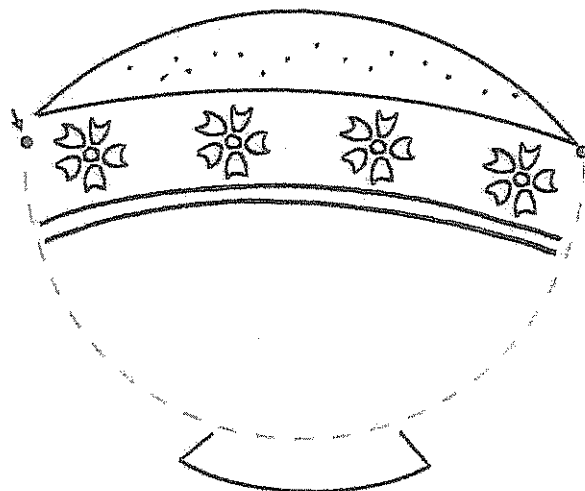
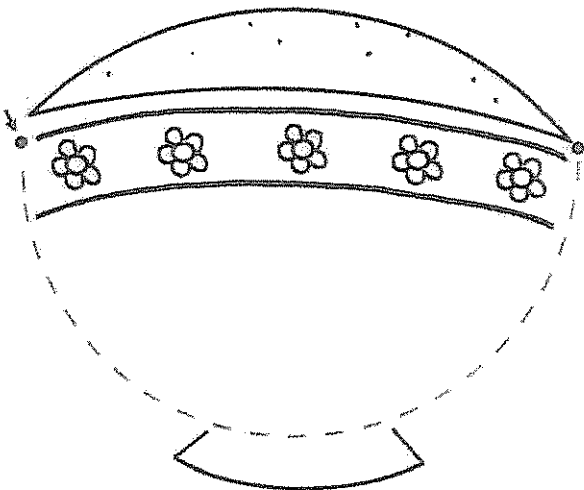
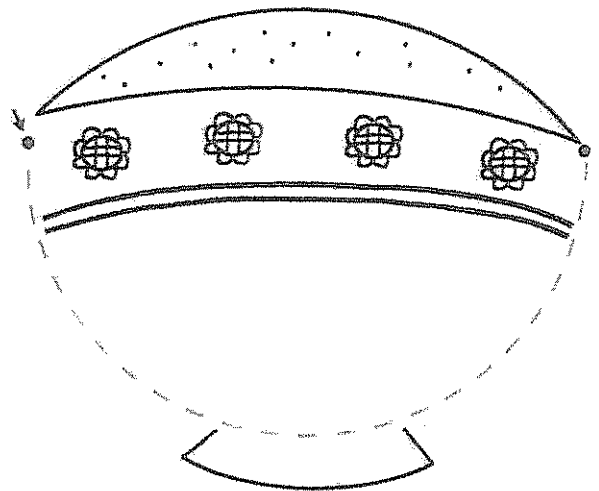
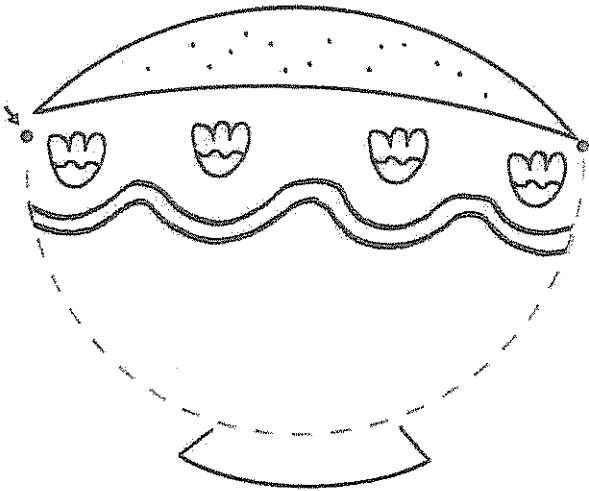



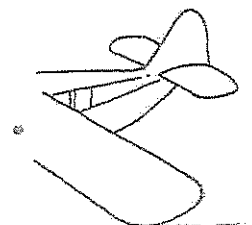
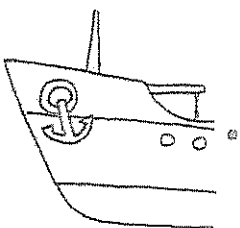
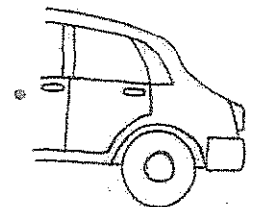
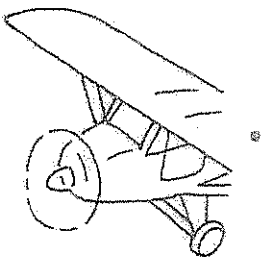
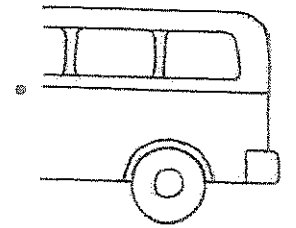
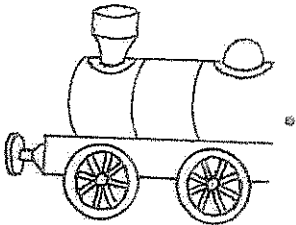
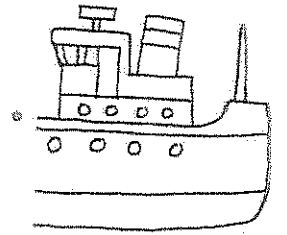
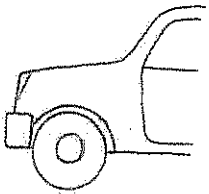
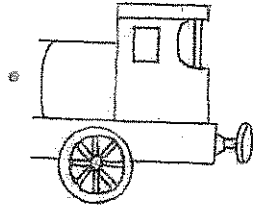
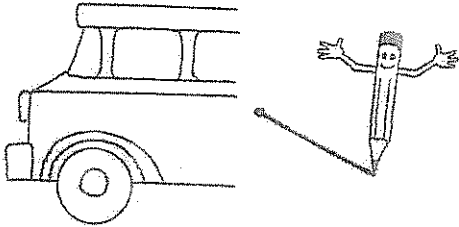





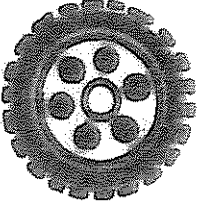

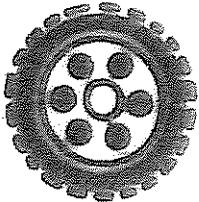

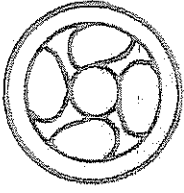
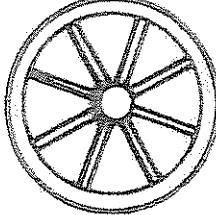
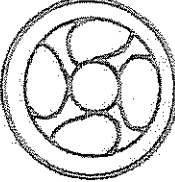
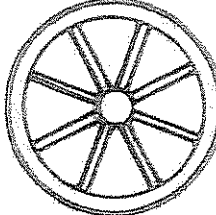
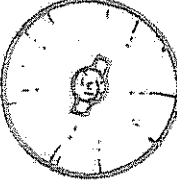

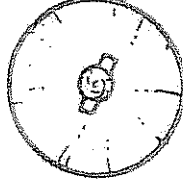

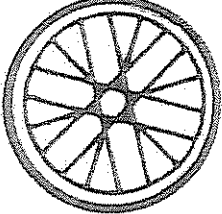

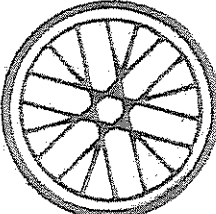
Matching Front and Back

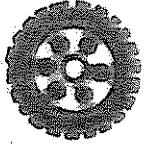
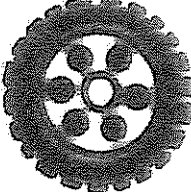

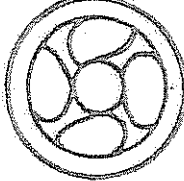
Tire and Wheel Patterns

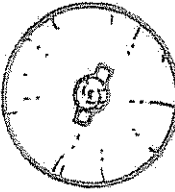
1. Do you see a pattern? What comes next?
2. Cut out the boxes below.
3. Glue the correct picture in the box.

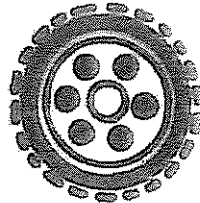

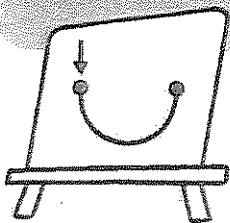

螞蟻找食物

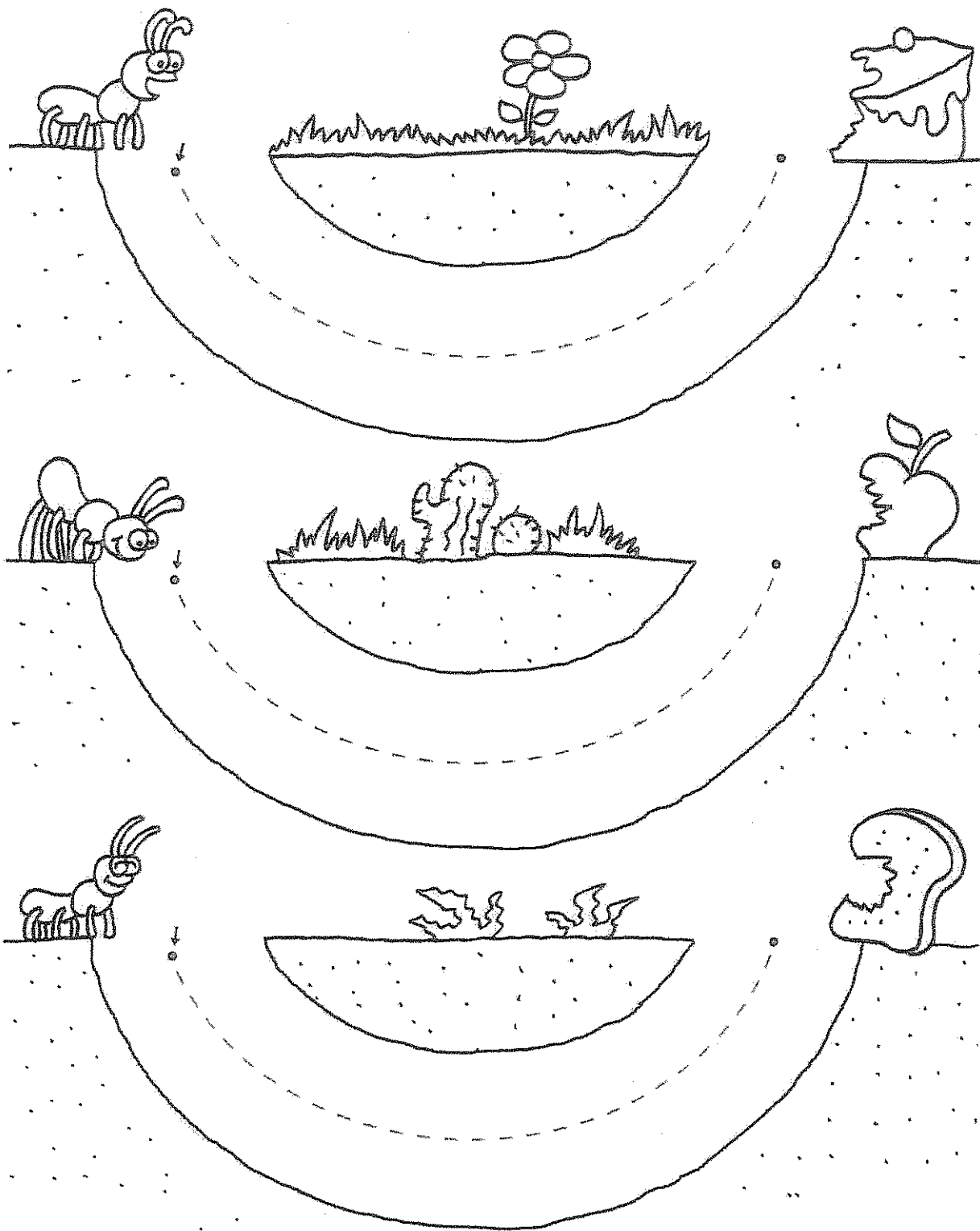

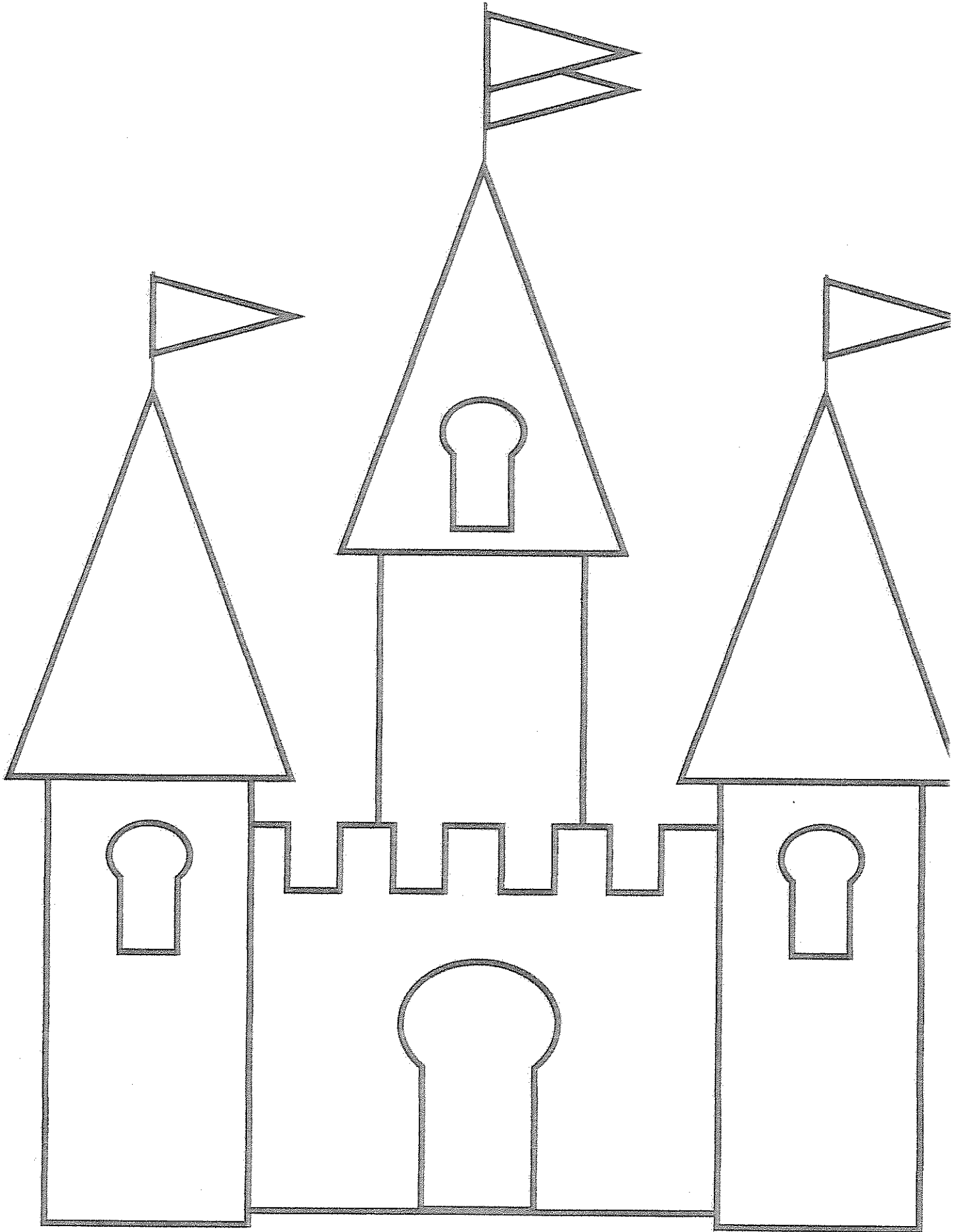

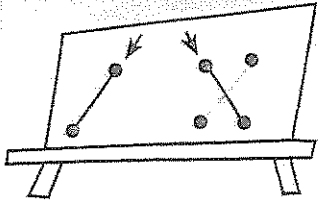

巨型球拍

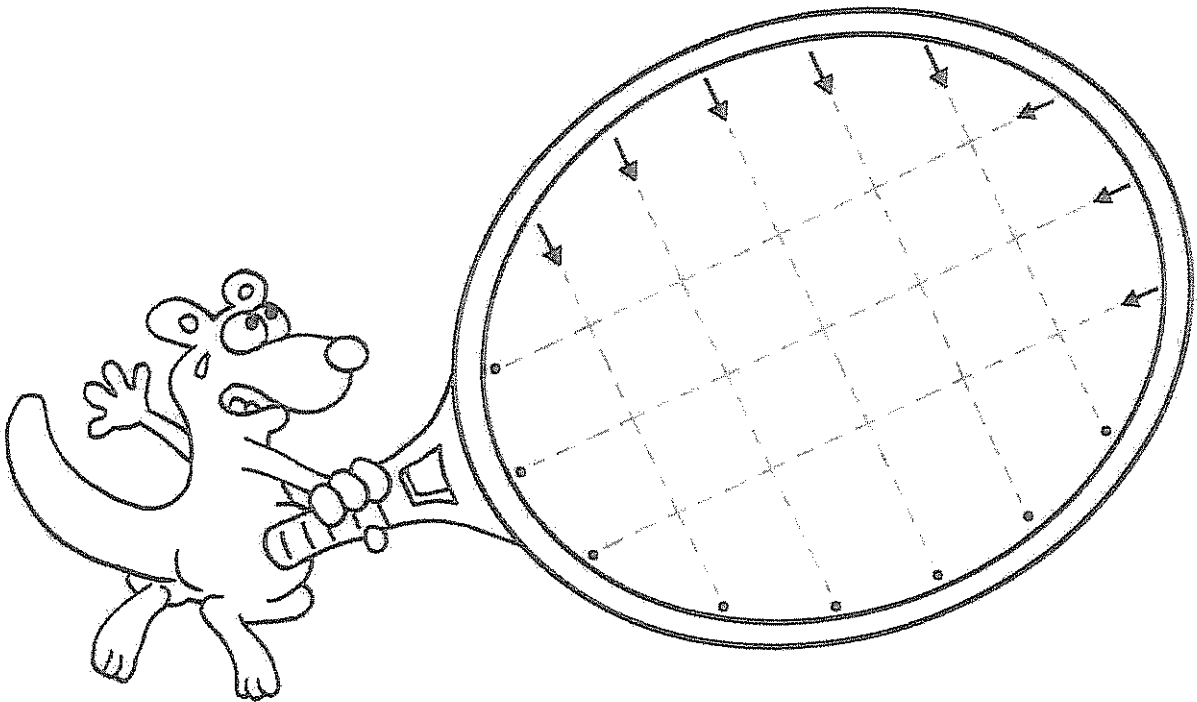
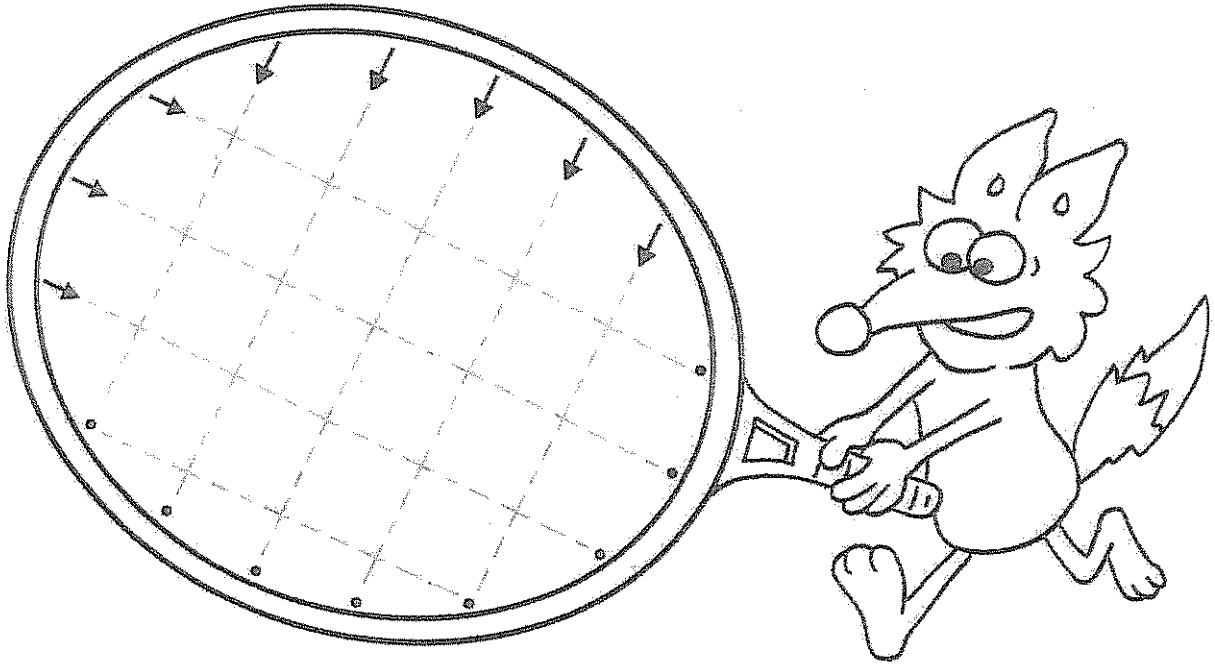

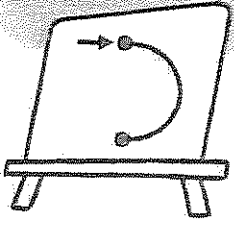

魚兒真美麗

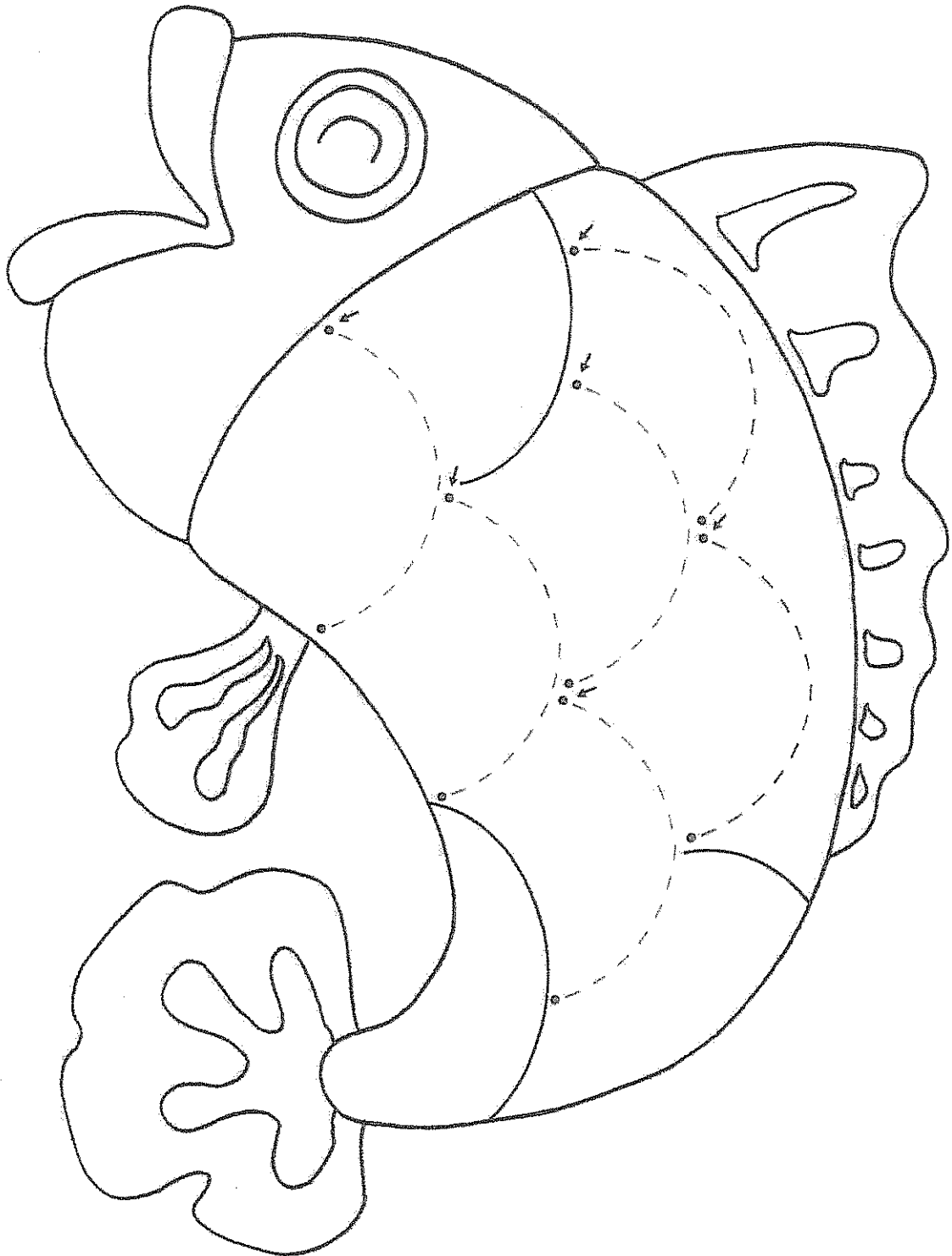

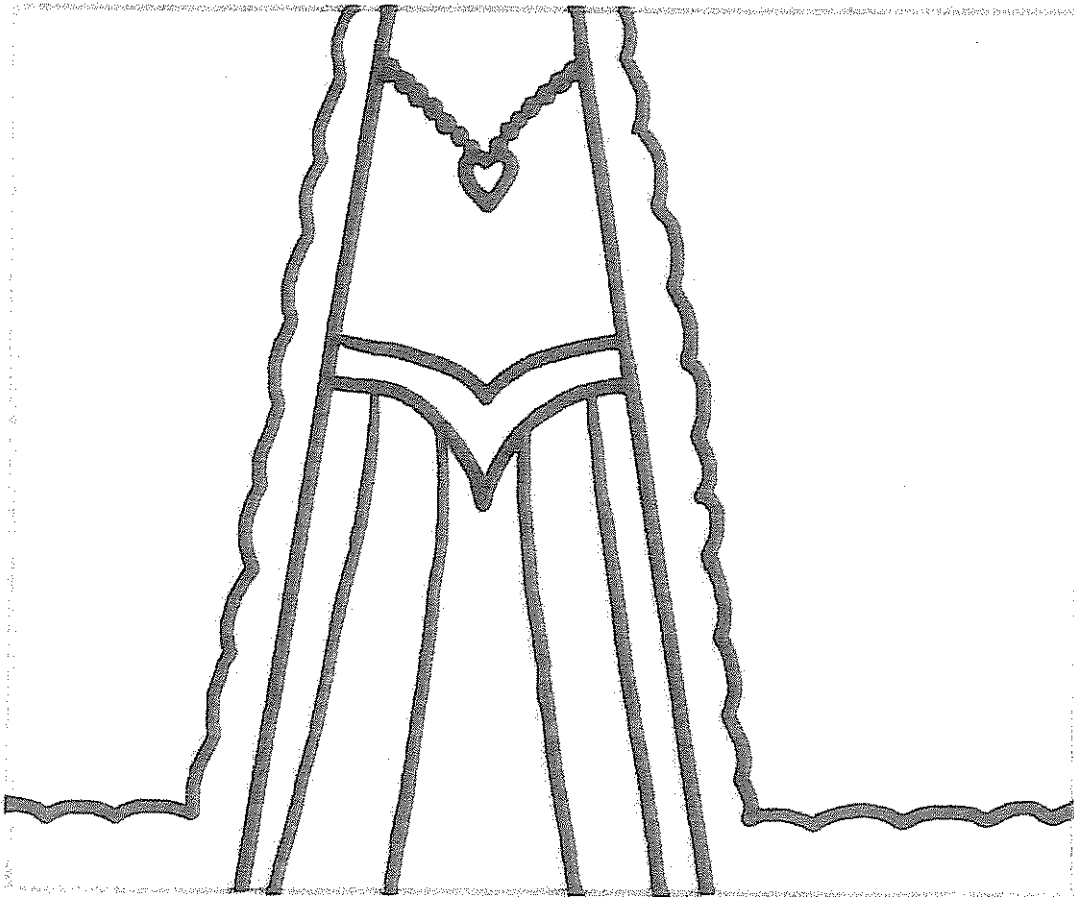
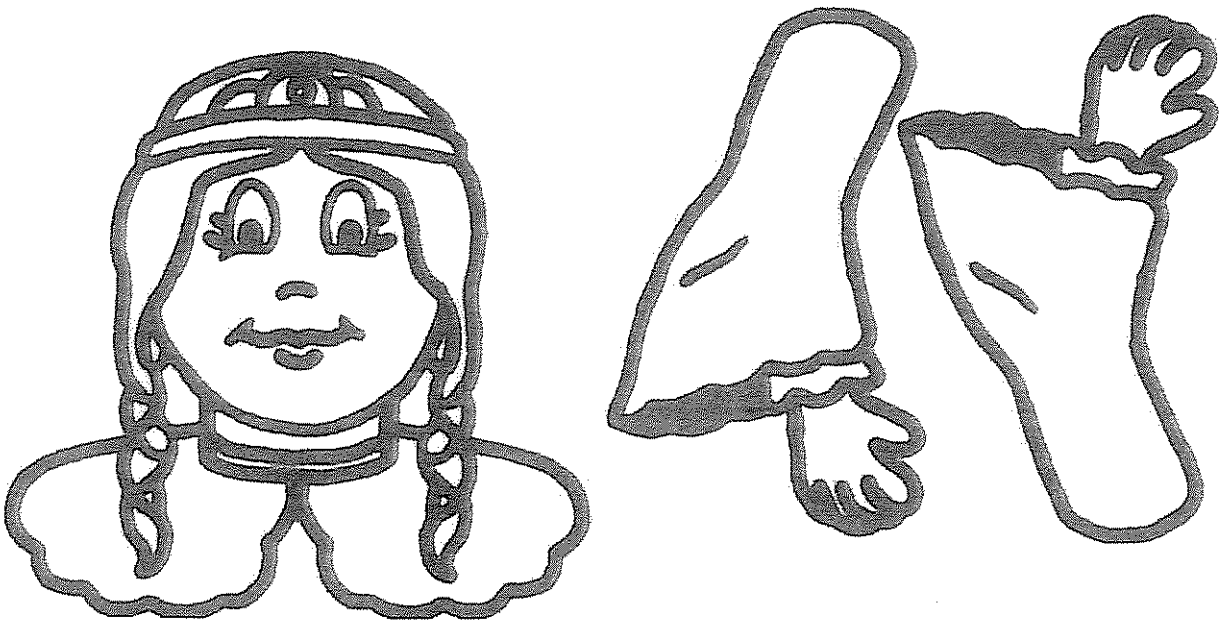

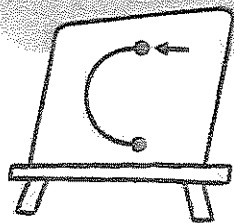
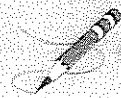

不同的球

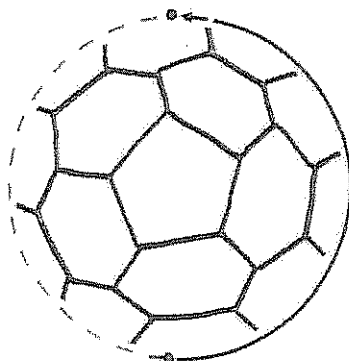
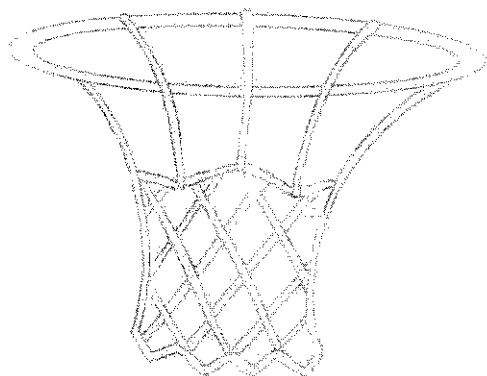
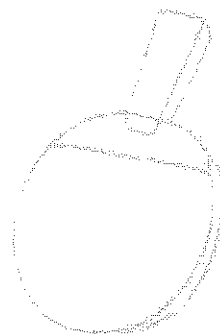
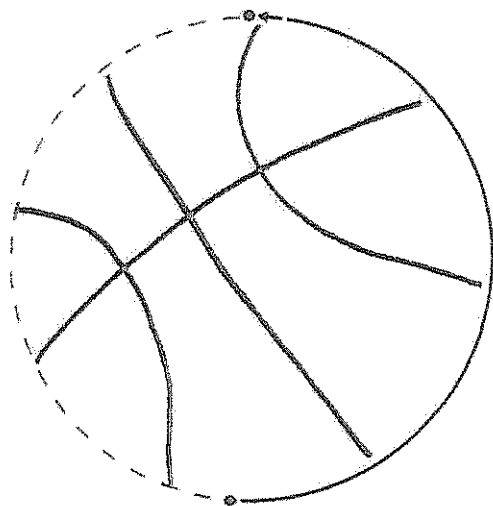
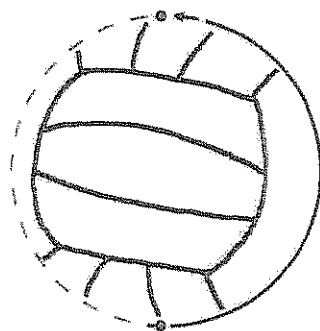

Thorn Rosa



Thorn Rosa was a princess fair, princess fair, princess fair.
Thorn Rosa was a princess fair. Long, long ago.

Stand in a circle, comb hair.

She lived up in a castle high, castle high, castle high
She lived up in a castle high. Long, long ago.

Raise hands over head and touch fingers together.

A wicked witch put a spell on her, spell on her, spell on her.
A wicked witch put a spell on her. Long, long ago.

Flick out fingers, casting a spell.

Thorn Rosa slept one hundred years, hundred years, hundred years.
Thorn Rosa slept one hundred years. Long, long ago.

Rest head on hands, sleeping.

The briar hedge grew oh so high, oh so high, oh so high.
The briar hedge grew oh so high. Long, long ago.

Everyone join hands and raise them up slowly.

A handsome prince came riding by, riding by, riding by.
A handsome prince came riding by. Long, long ago.

Gallop in a circle, clockwise.

The princess awakened at his touch, at his touch, at his touch.
The princess awakened at his touch. Long, long ago.

Rub eyes and stretch, waking up.

The prince and princess rode away, rode away, rode away.
The prince and princess rode away. Long, long ago.

Gallop in a circle, counter-clockwise.

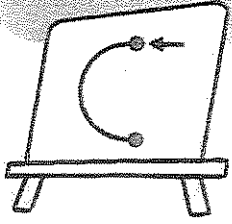

帆船

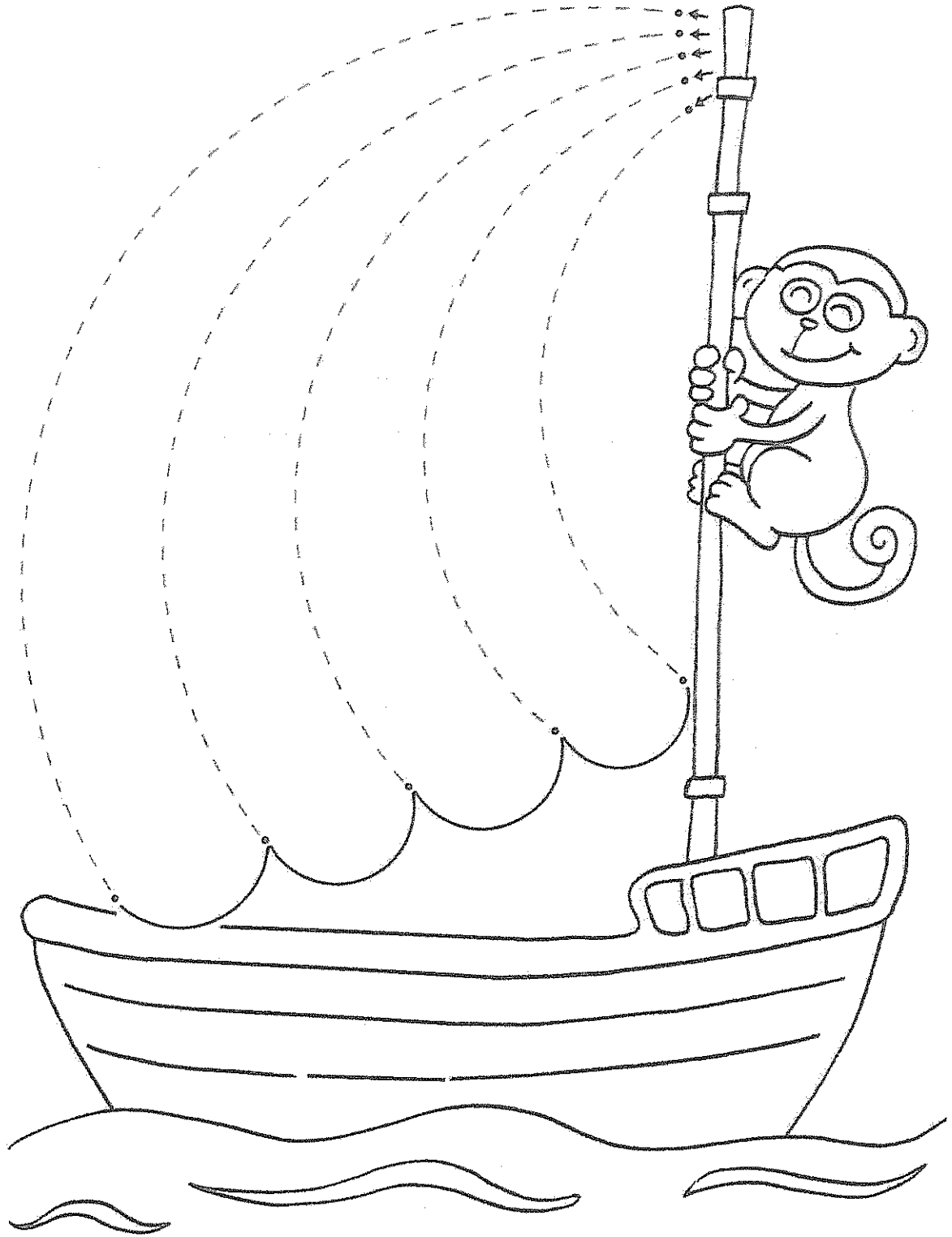

FINGER PUPPETS

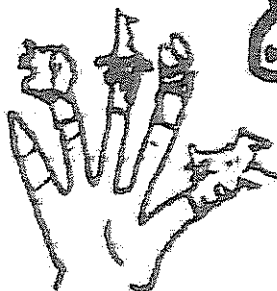
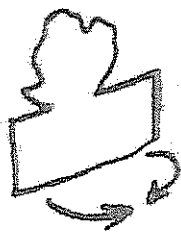
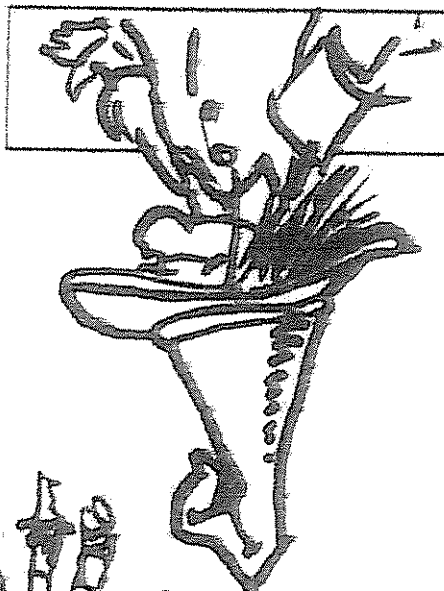
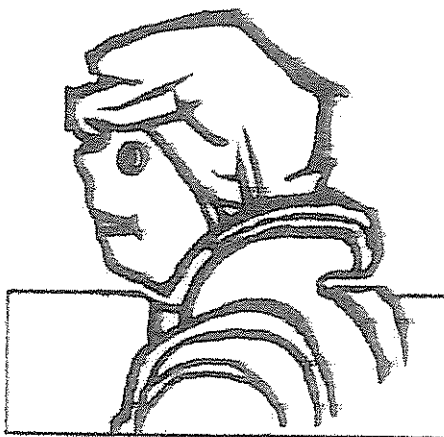
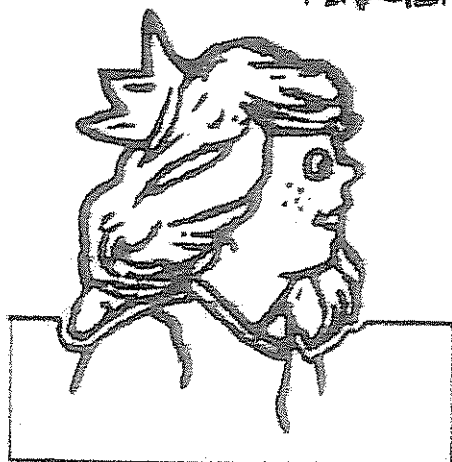

Cut out, wrap tab around finger and tape

(c) Dean Fortune, Pinellas Park Public Library

Template 3

King's crown

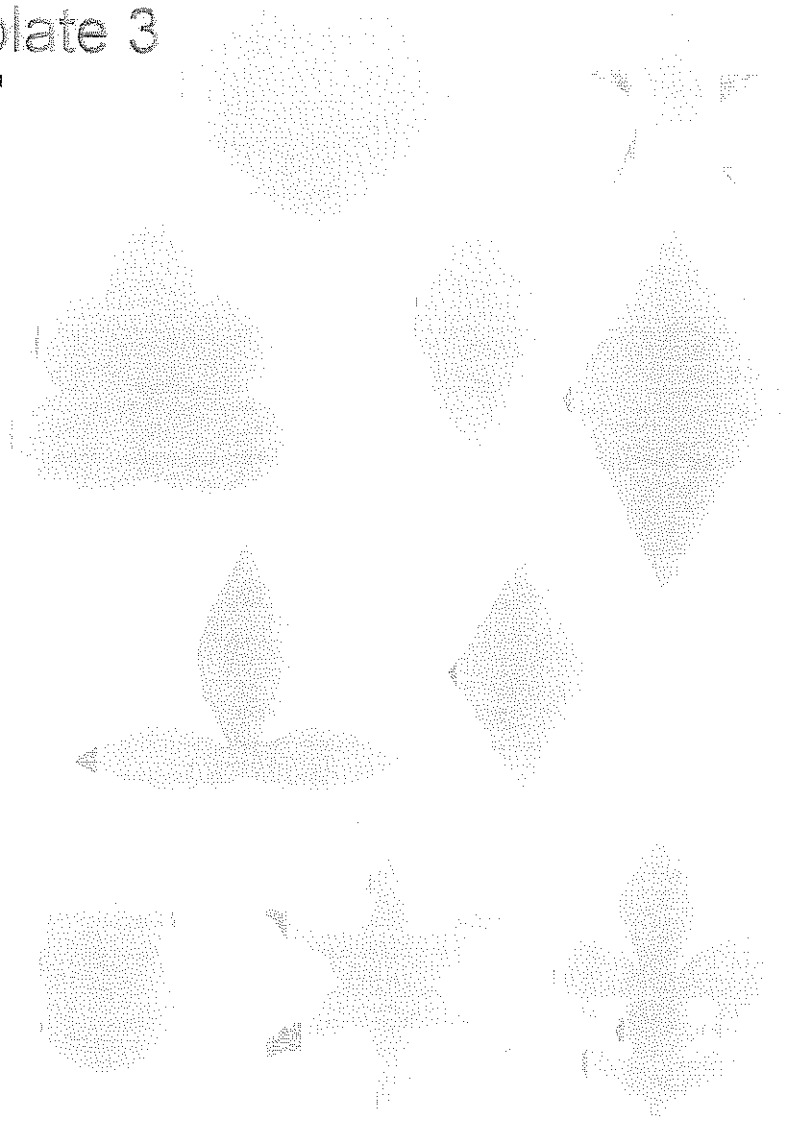

ph | **powerhouse.museum**
science + design
500 Harris St Ultimo
PO Box K346 Haymarket NSW 1238 Australia
tel: 02 6217 0111
web: <http://play.powerhousemuseum.com>

This work is licensed under the Creative Commons Attribution-NonCommercial-ShareAlike 2.5 License.

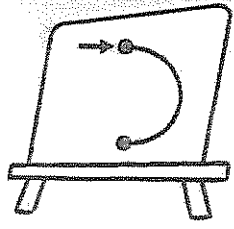

香蕉

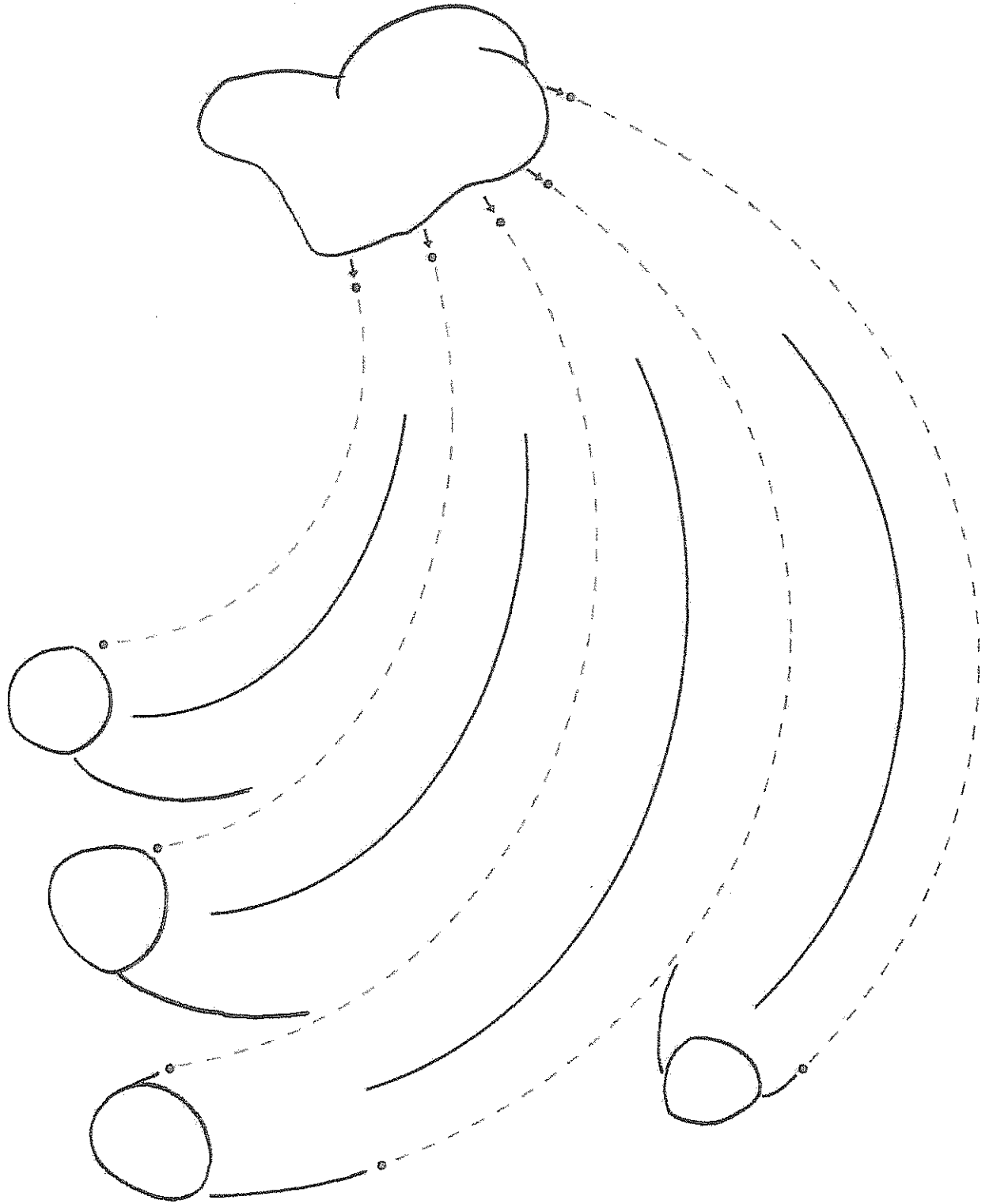

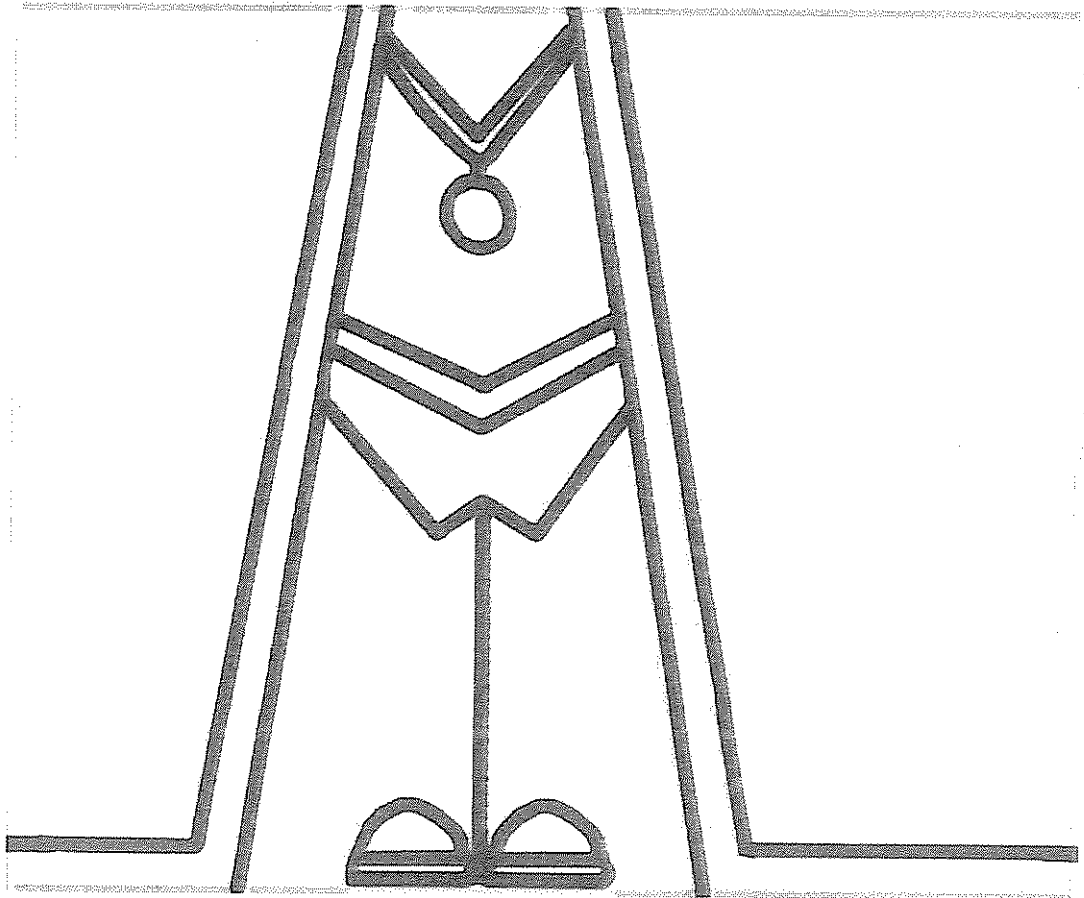
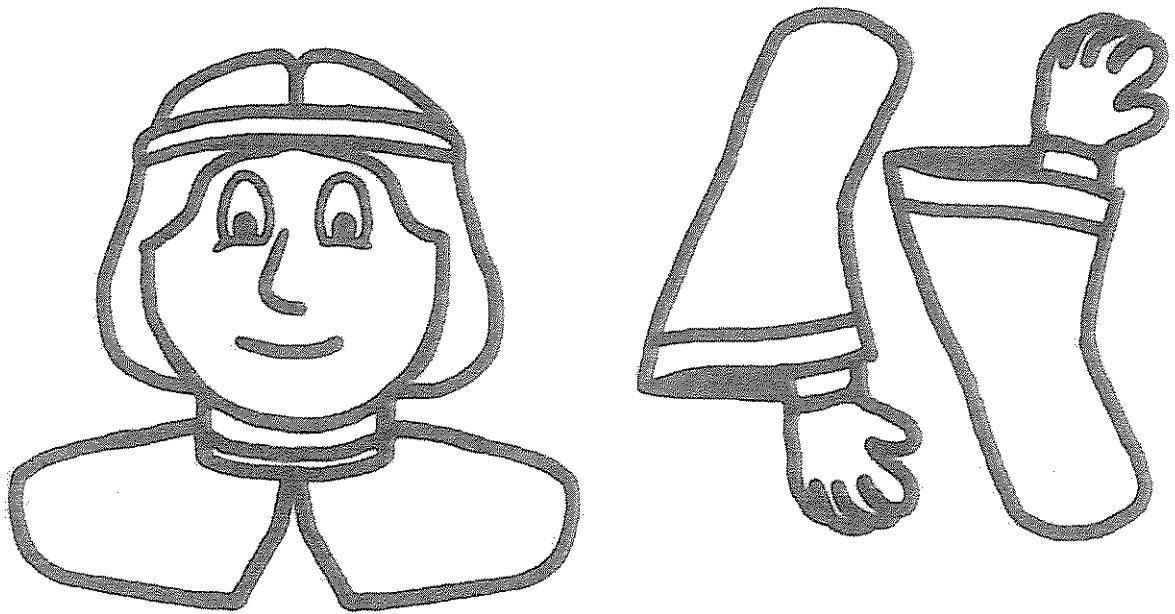

Play at Powerhouse

make & do activity kit

Template 2

King's crown

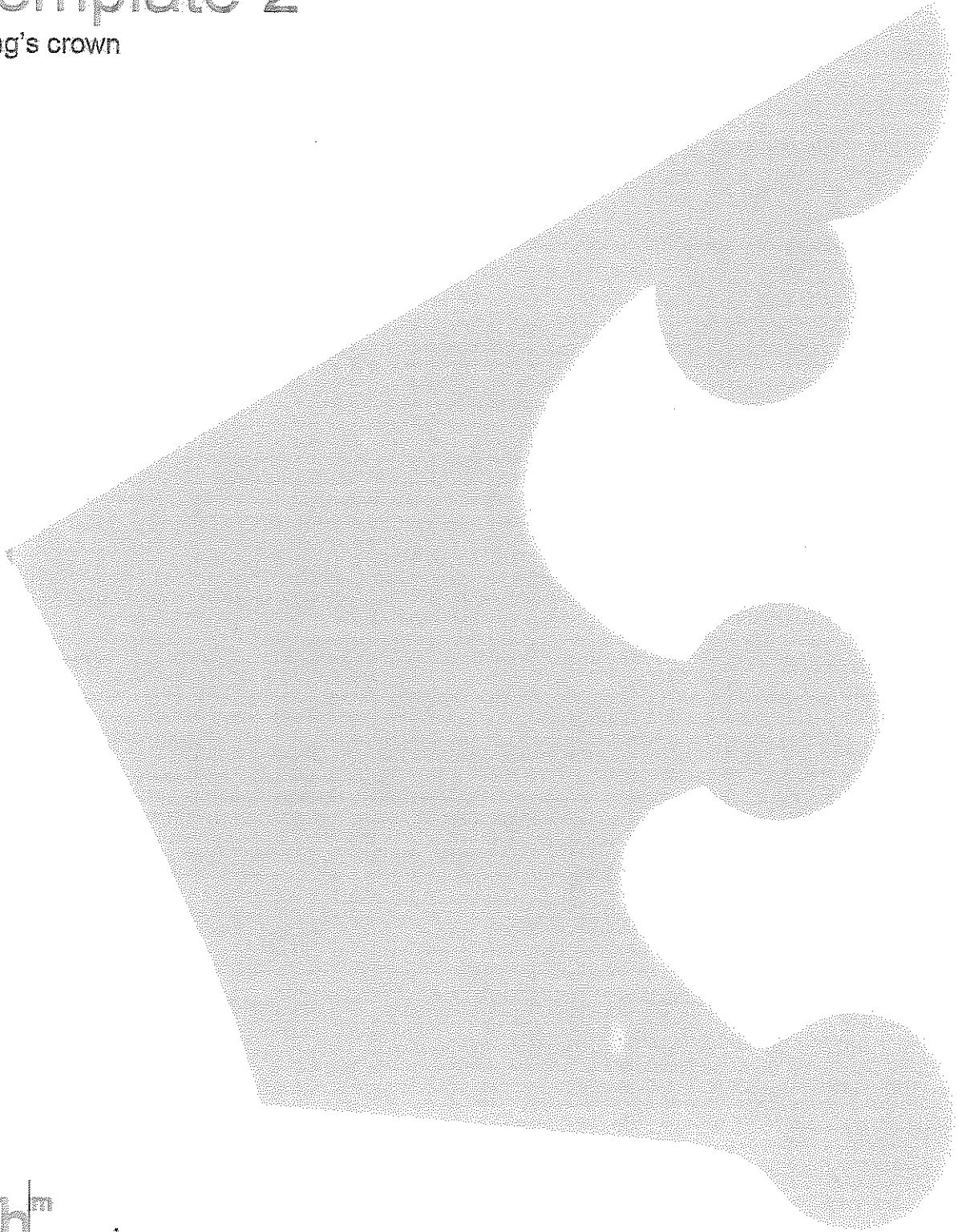

King's crown



This activity kit contains:

1. Make and do activity steps 1 - 5
2. Three template pages

Visit <http://play.powerhousemuseum.com> to download any missing elements.

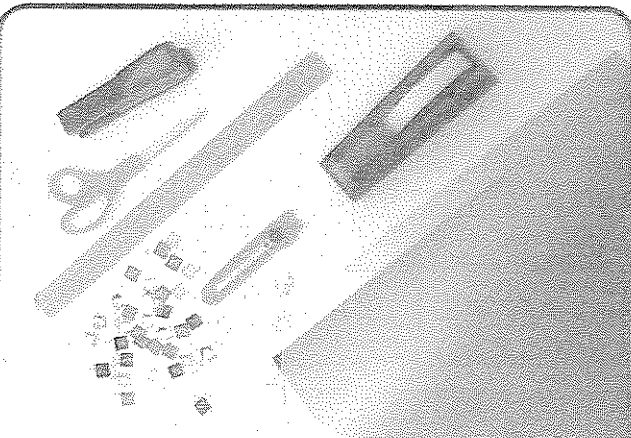

Things you need:

metallic or coloured card
craft glue
beads, jewels, or other decorations
scissors & craft knife
ruler
stapler
sticky-tape

1 Print out the crown templates, cut out the shapes and stick them together to make your crown pattern.

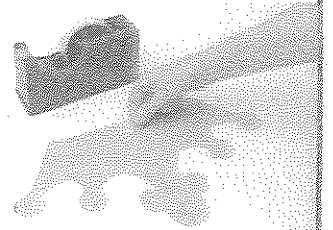

2 Sticky tape the pattern to the back of a sheet of cardboard. Cut out the crown with scissors.

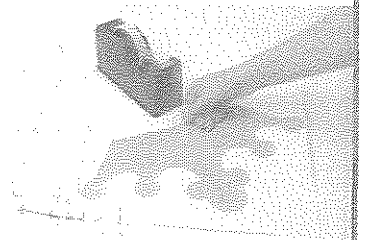

3 Use the decorative motifs on the third template, beads, crystals, glitters or coloured and metallic papers to decorate your crown.



4 Cut out a band of cardboard about 3cm wide and 50cm long. Fit it to your head and staple the ends to the sides of the crown. Cut off the excess cardboard.

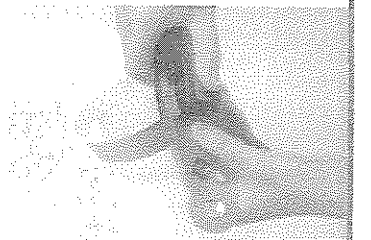

5 Place some sticky-tape over the staples to protect your skin from scratches.

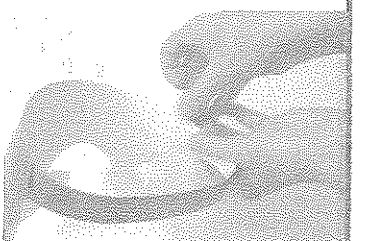

powerhouse museum
science+design

500 Harris St Ultimo
PO Box K346 Haymarket NSW 1238 Australia
tel: 02 6217 0111
web: <http://play.powerhousemuseum.com>

Sweet Mom's Candy Crown Template

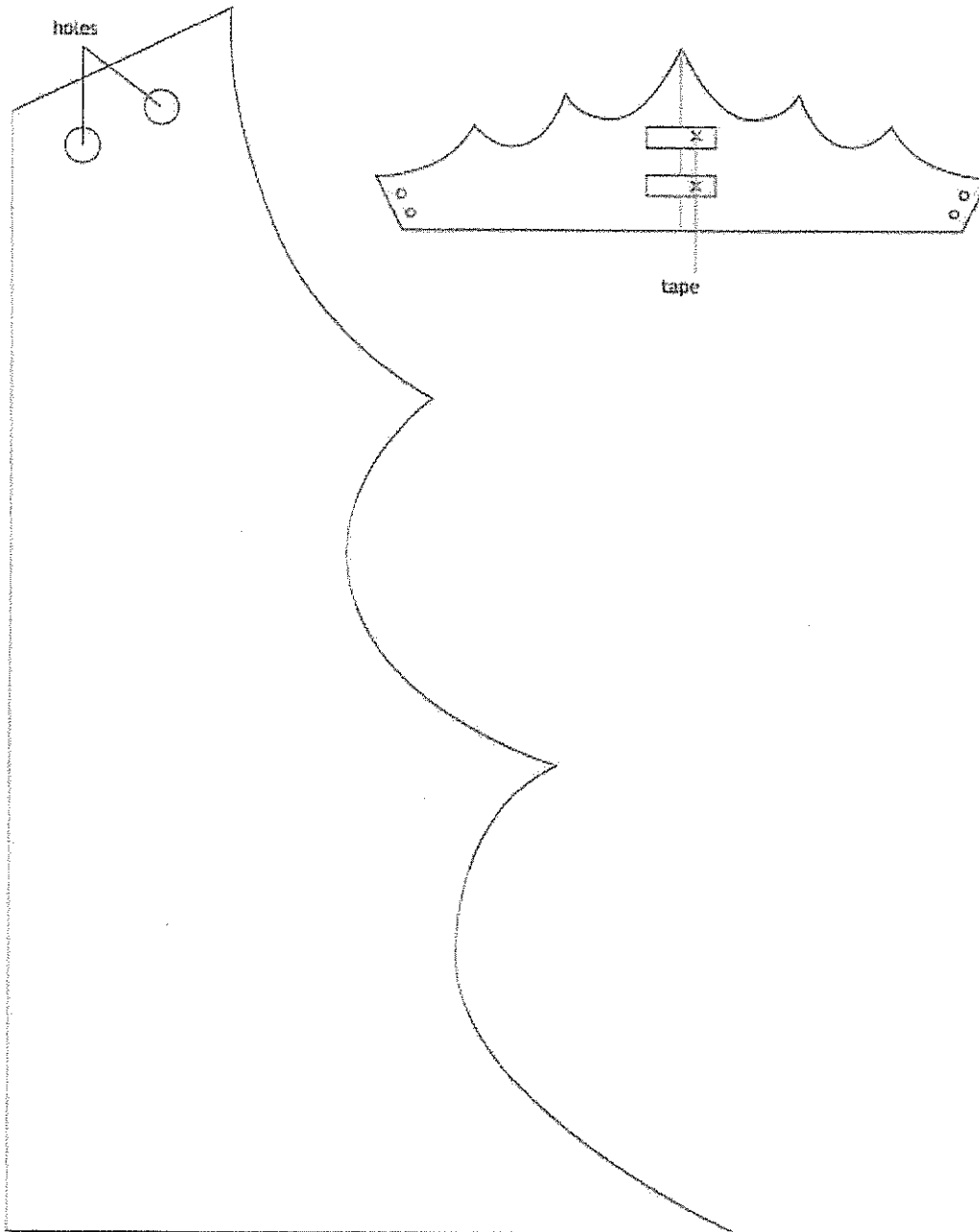

Sweet Mom's Candy Crown Template

